



HOLLYWOOD

A Hollywood Sunscreen is an effective system that is perfect for obscuring rooftop equipment, or as a decorative wall panel for added curb appeal on any property. These aluminum constructed sunscreens are offered with multiple cladding options and can be applied in multiple orientations and angles to achieve a custom appearance. A Hollywood sunscreen is a great finishing touch. **Made in the U.S.A.**

ROOFSCREEN STRUCTURES



LOW FRAME

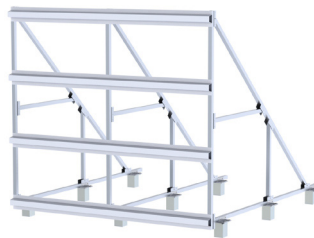

HIGH FRAME

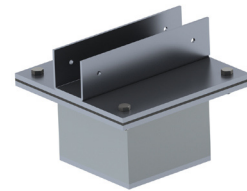

ROOF MOUNTED
BASE PLATE

CLADDING OPTIONS

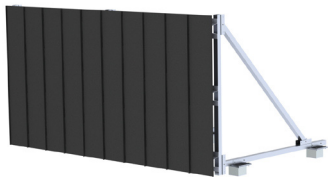

STANDING SEAM



LOUVER



CORRUGATED

WALL PANELS

Standing out in a crowded market is easy with the Hollywood wall panels. Choose from our standard designs or let us create a custom solution to fit your properties' theme.



LOUVER WALL PANEL EXAMPLE

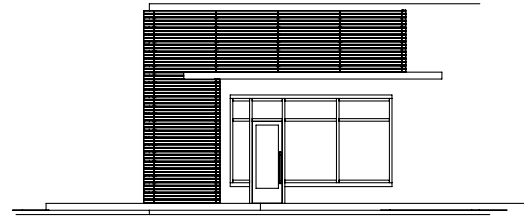
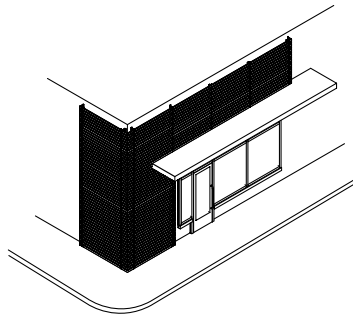
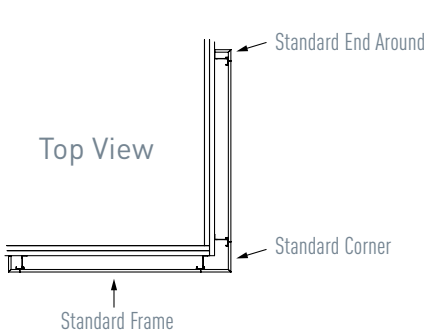

LOUVER WALL PANEL EXAMPLE

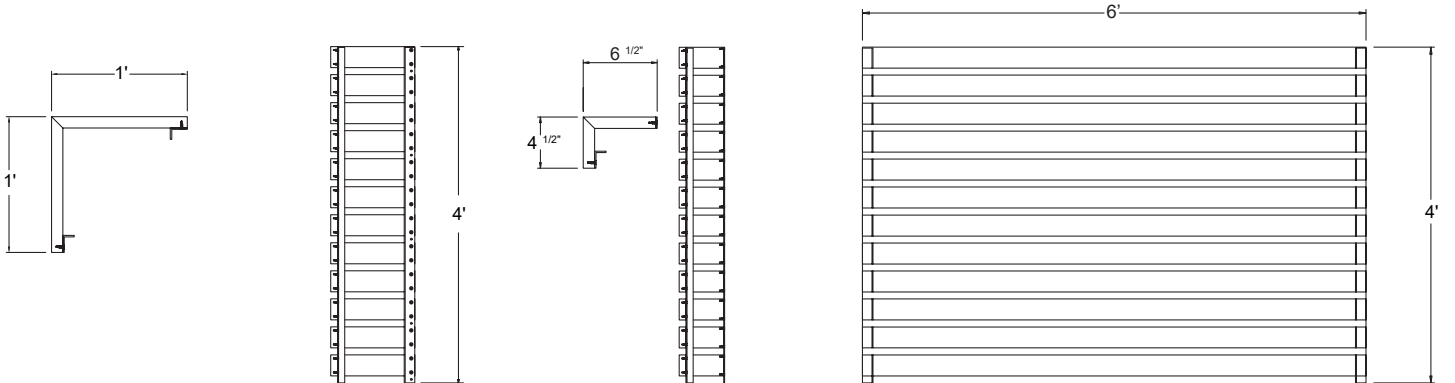

1 x 3 Slats

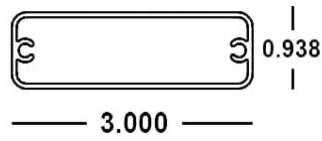
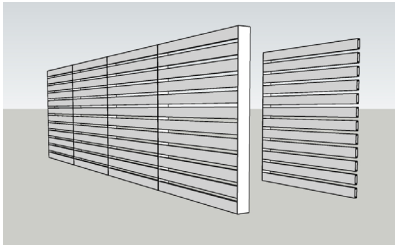

1 x 4 Slats

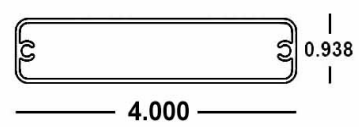
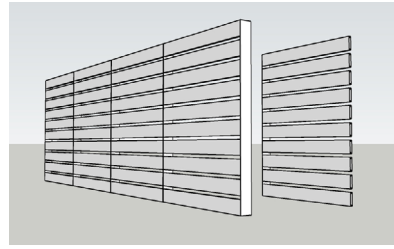

1 x 5 Slats

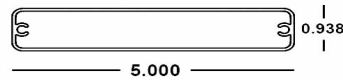
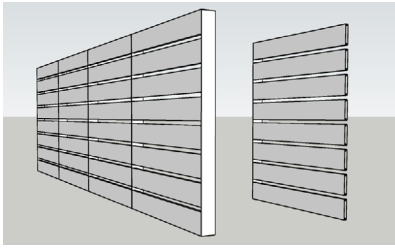

2" Airfoils

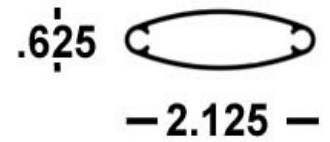
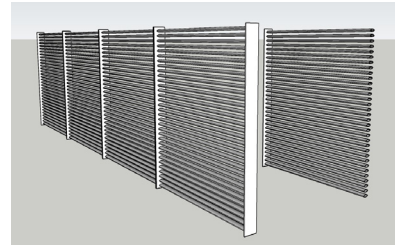

2" Diameter

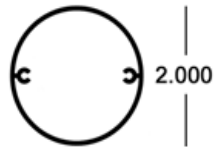
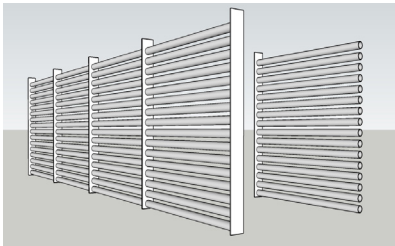

4" Airfoils

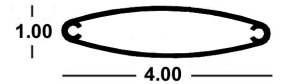
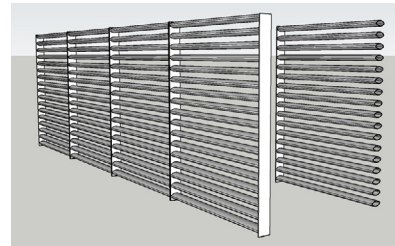

4" Diameter

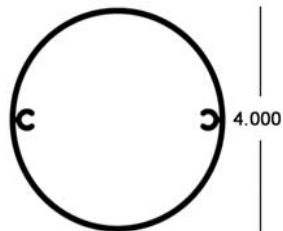
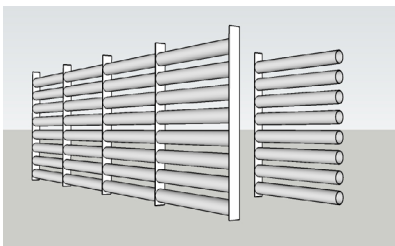

5" Shadow

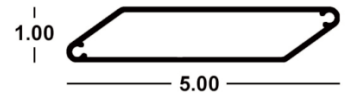
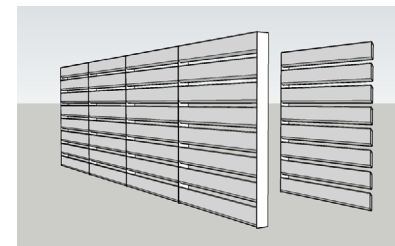

10" Airfoils

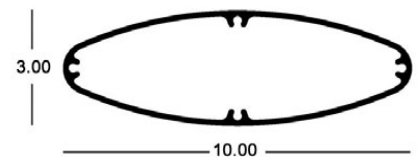
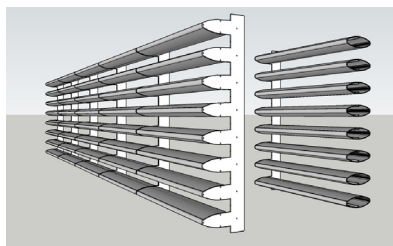
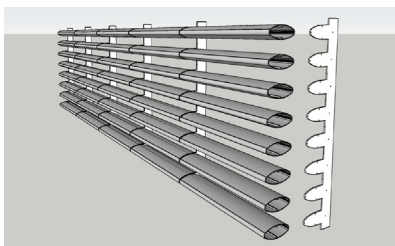

*Lead times vary based on extrusions